

[제품 도면]

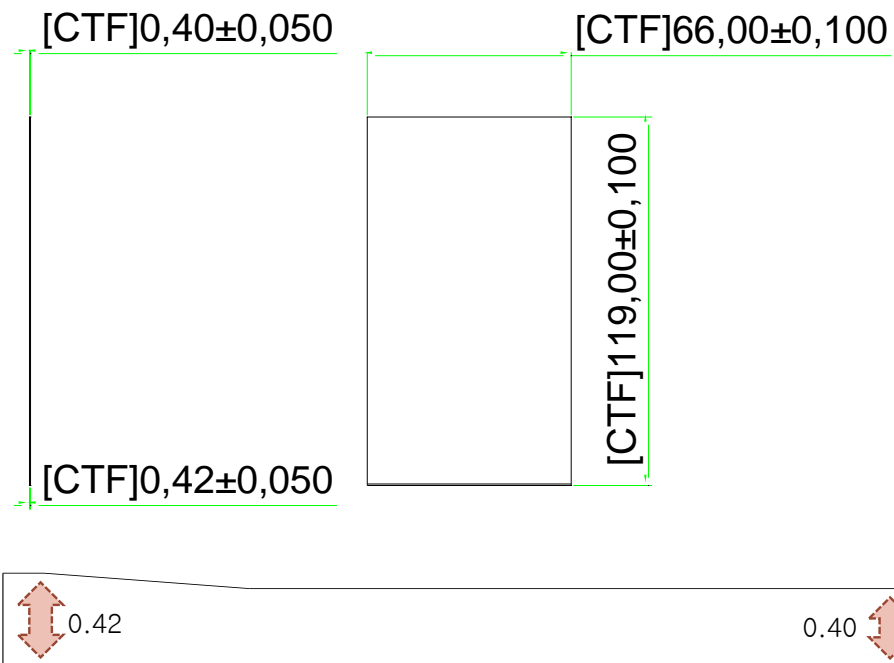

<Side View>

◆ Features

Parameter	Specification	Unit
Out Size	5.3"	Inch
	66.00(H) * 119.00(V) * 0.40(T)	mm
Structure	Top Face : Lenticular Pattern Bottom Face : Dot Pattern	-
Type	0.40T~0.42T (Wedge Type)	mm
	Flat Face : 0.40T Wedge : 0.42T	mm
Mirror Finishing	N/A	-
Remark	RoHS ,HF	-

◆ INV15G-5.4-01S

■ Light Guide Film

[제품 도면]

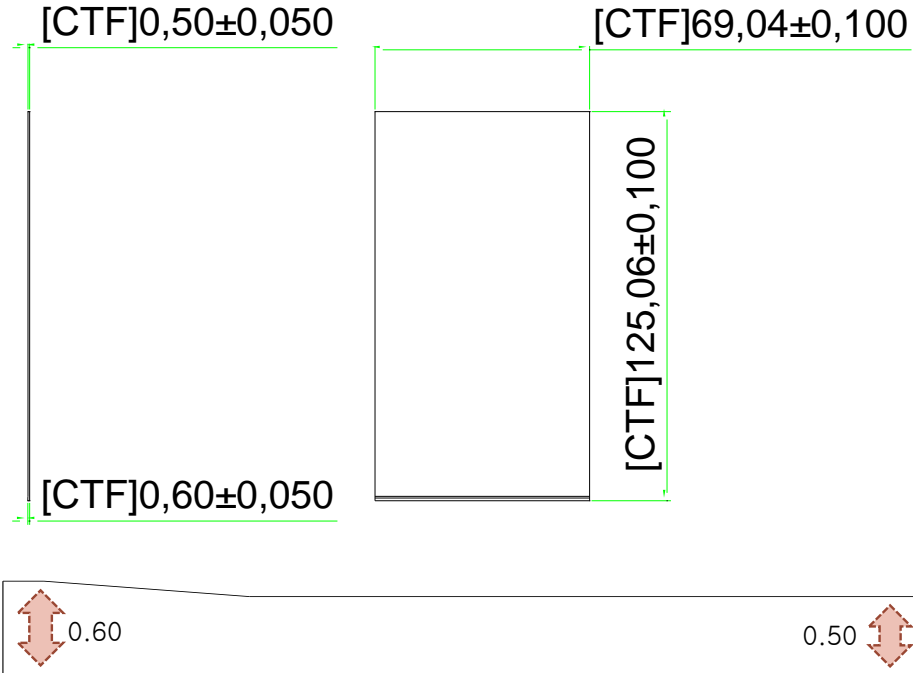

◆ Features

Parameter	Specification	Unit
Out Size	5.46"	Inch
	69.04(H) * 125.06(V) * 0.50(T)	mm
Structure	Top Face : UV varnish (clear) Bottom Face : Polycarbonate	-
Type	0.50T~0.60T (Wedge Type)	mm
	Flat Face : 0.50T Wedge : 0.60T	mm
Mirror Finishing		Four Faces
Remark	RoHS ,HF	-

◆ INV15G-5.7-01S

■ Light Guide Film

[제품 도면]

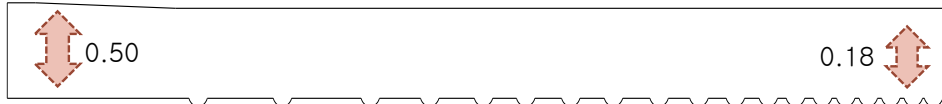
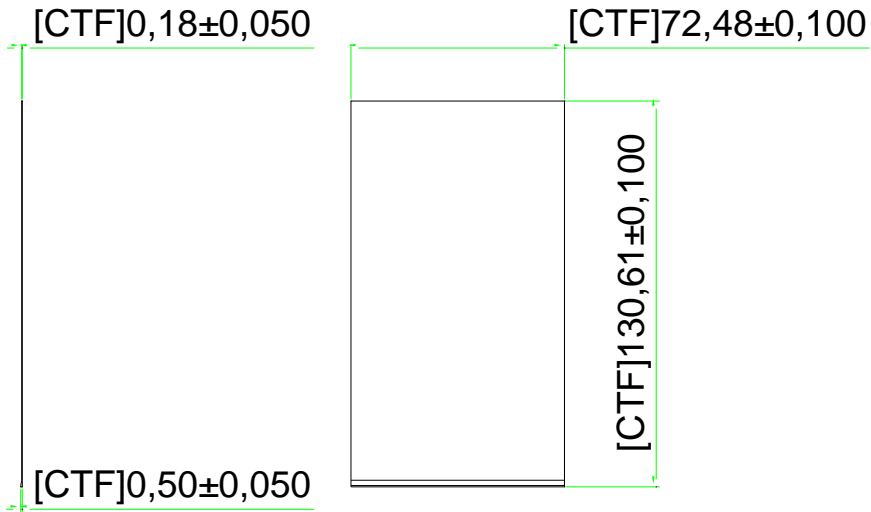

<Side View>

◆ Features

Parameter	Specification	Unit
Out Size	5.7"	Inch
	72.48(H) * 130.61(V) * 0.18(T)	mm
Structure	Top Face : UV varnish (clear) Bottom Face : Dot Pattern	-
Type	0.18T~0.50T (Wedge Type)	mm
	Flat Face : 0.18T Wedge : 0.50T	mm
Mirror Finishing		Four Faces
Remark	RoHS ,HF	-

◆ INV15G-5.7-02S

■ Light Guide Film

[제품 도면]

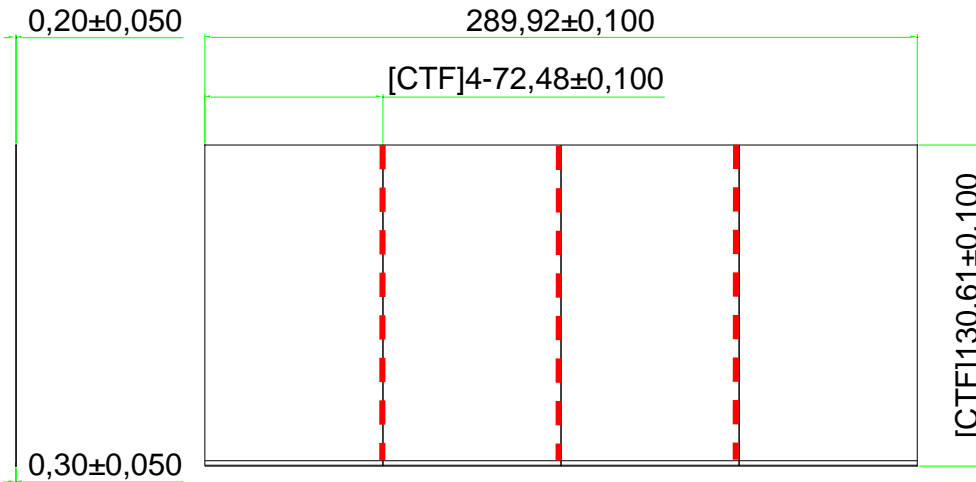

<Side View>

◆ Features

Parameter	Specification	Unit
Out Size	5.7" (4-Array)	Inch
	72.48(H) * 130.61(V) * 0.20(T)	mm
Structure	Top Face : UV varnish (clear) Bottom Face : Polycarbonate	-
Type	0.20T~0.30T (Wedge Type)	mm
	Flat Face : 0.20T Wedge : 0.30T	mm
Mirror Finishing		Four Faces
Remark	RoHS ,HF	-

◆ INV15G-5.7-03S

■ Light Guide Film

[제품 도면]

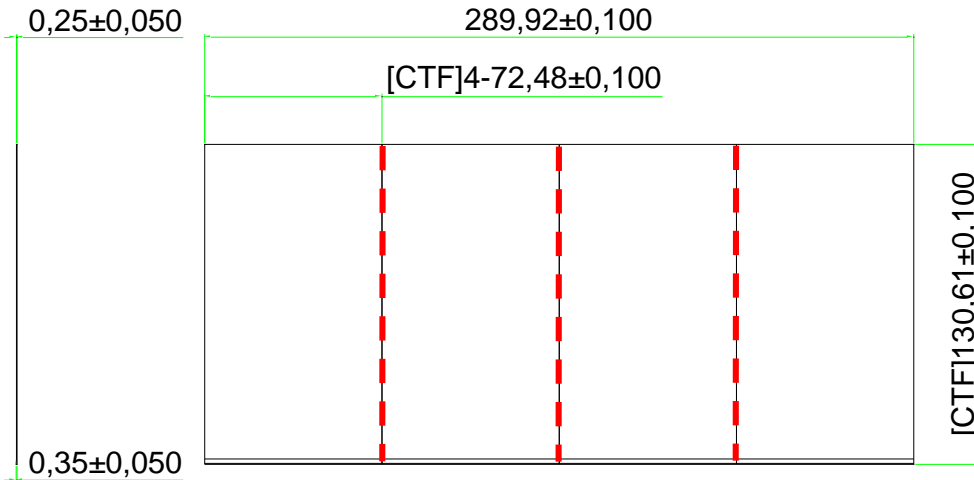

<Side View>

◆ Features

Parameter	Specification	Unit
Out Size	5.7" (4-Array)	Inch
	72.48(H) * 130.61(V) * 0.25(T)	mm
Structure	Top Face : UV varnish (clear) Bottom Face : Polycarbonate	-
Type	0.25T~0.35T (Wedge Type)	mm
	Flat Face : 0.25T Wedge : 0.35T	mm
Mirror Finishing		Four Faces
Remark	RoHS ,HF	-

◆ INV15G-5.7-04S

■ Light Guide Film

[제품 도면]

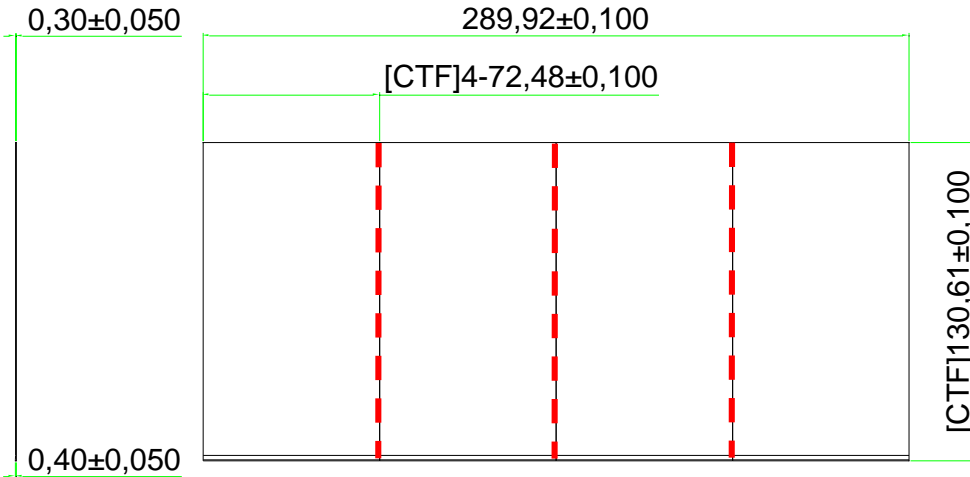

<Side View>

◆ Features

Parameter	Specification	Unit
Out Size	5.7" (4-Array)	Inch
	72.48(H) * 130.61(V) * 0.30(T)	mm
Structure	Top Face : UV varnish (clear) Bottom Face : Polycarbonate	-
Type	0.30T~0.40T (Wedge Type)	mm
	Flat Face : 0.30T Wedge : 0.40T	mm
Mirror Finishing		Four Faces
Remark	RoHS ,HF	-

◆ INV15F-08-01S

■ Light Guide Film

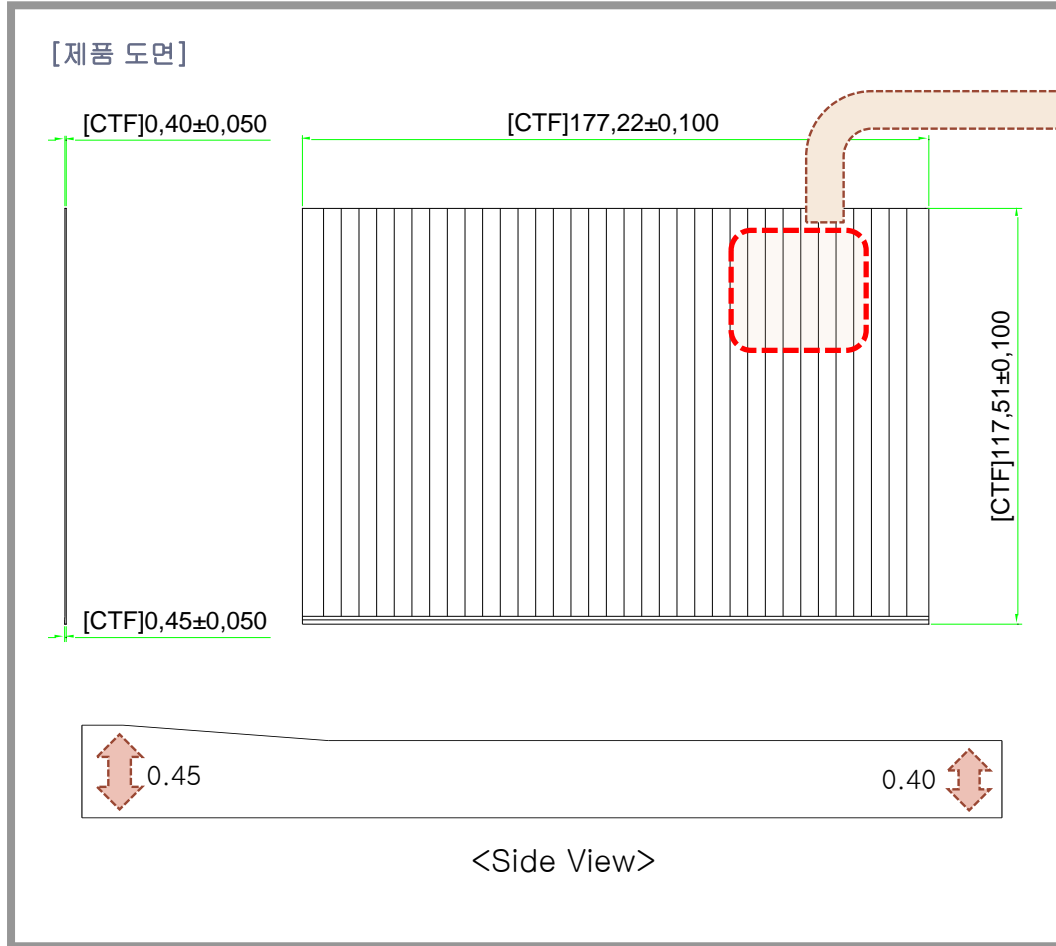

◆ Lenticular Pattern (Top Face)

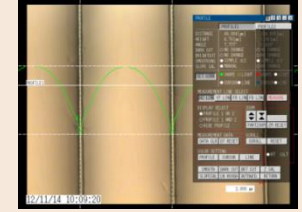
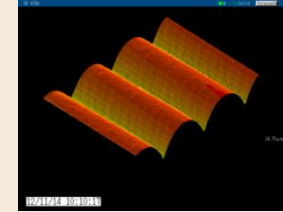

- Pitch : 50um - height : 7um

◆ Features

Parameter	Specification	Unit
Out Size	8"	Inch
	177.22(H) * 117.51(V) * 0.40(T)	mm
Structure	Top Face : UV varnish (clear) Bottom Face : Polycarbonate	-
Type	0.40T~0.45T (Wedge Type)	mm
	Flat Face : 0.40T Wedge : 0.45T	mm
Mirror Finishing		Four Faces
Remark	RoHS ,HF	-

◆ INV15F-08-02S

■ Light Guide Film

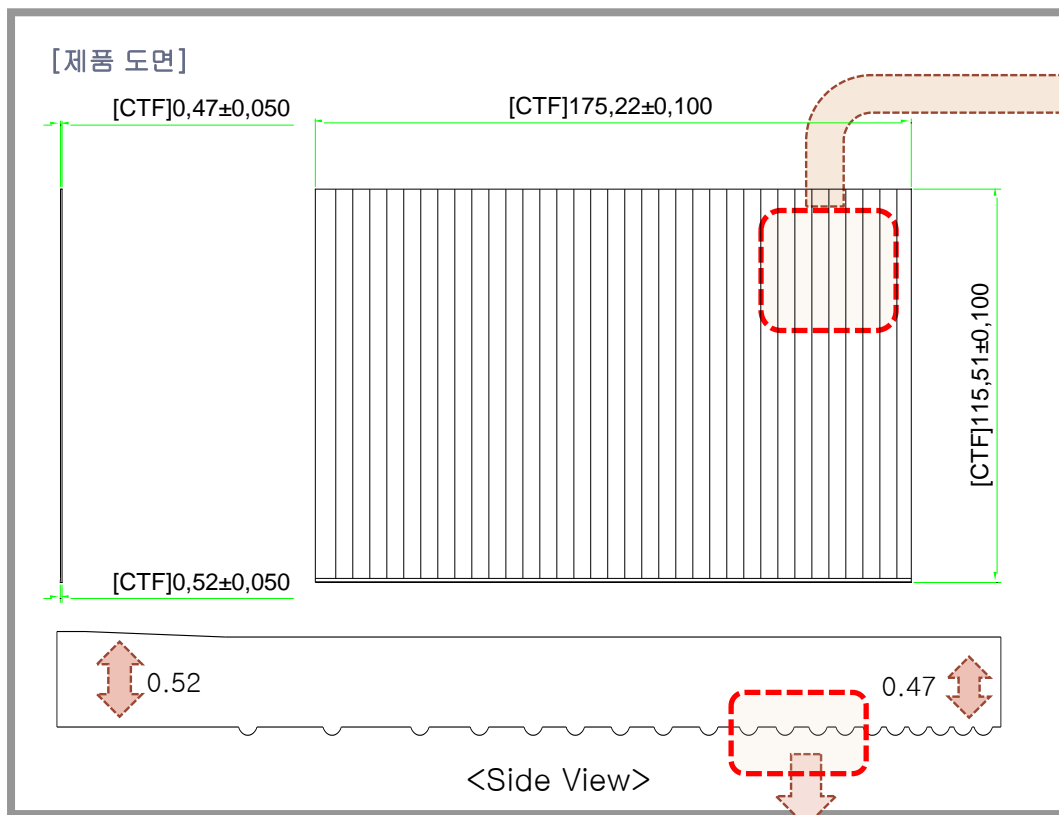

◆ Roll Stamping Pattern (Bottom Face)

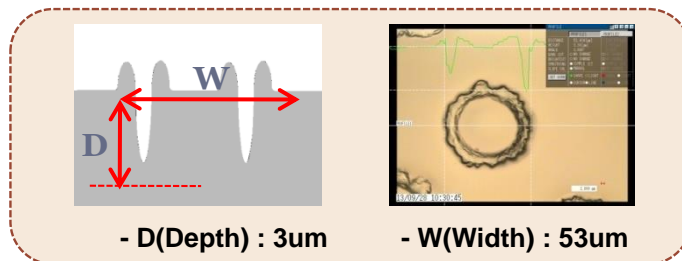

◆ Lenticular Pattern (Top Face)

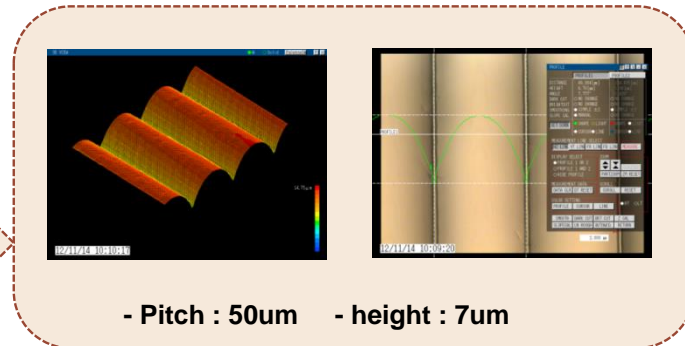

◆ Features

Parameter	Specification	Unit
Out Size	8"	Inch
	175.22(H) * 115.51(V) * 0.47(T)	mm
Structure	Top Face : UV varnish (clear) Bottom Face : Polycarbonate	-
Type	0.47T~0.52T (Wedge Type)	mm
	Flat Face : 0.47T Wedge : 0.52T	mm
Mirror Finishing		Four Faces
Remark	RoHS ,HF	-

◆ INV15F-08-03S

■ Light Guide Film

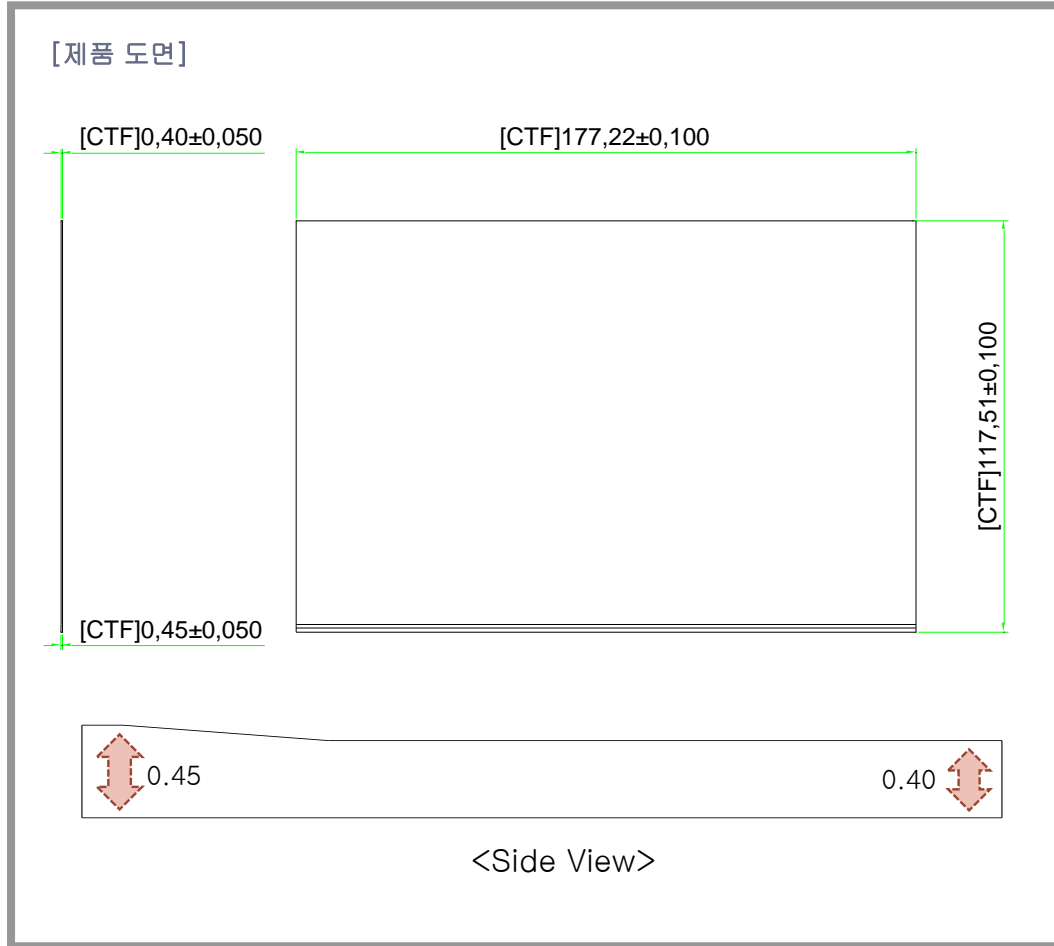

◆ Features

Parameter	Specification	Unit
Out Size	8"	Inch
	177.22(H) * 117.51(V) * 0.40(T)	mm
Structure	Top Face : UV varnish (clear) Bottom Face : Polycarbonate	-
Type	0.40T~0.45T (Wedge Type)	mm
	Flat Face : 0.40T Wedge : 0.45T	mm
Mirror Finishing		Four Faces
Remark	RoHS ,HF	-

◆ INV15F-14-01S

■ Light Guide Film

[제품 도면]

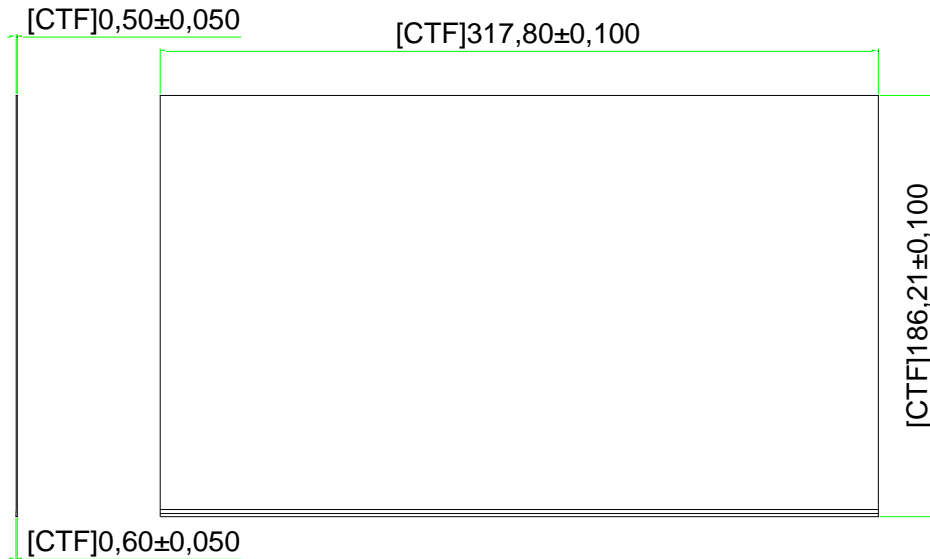

<Side View>

◆ Features

Parameter	Specification	Unit
Out Size	14"	Inch
	317.80(H) * 186.21(V) * 0.50(T)	mm
Structure	Top Face : UV varnish (clear) Bottom Face : Polycarbonate	-
Type	0.50T~0.60T (Wedge Type)	mm
	Flat Face : 0.50T Wedge : 0.60T	mm
Mirror Finishing		Four Faces
Remark	RoHS ,HF	-

◆ INV15F-15.6-01S

■ Light Guide Film

[제품 도면]

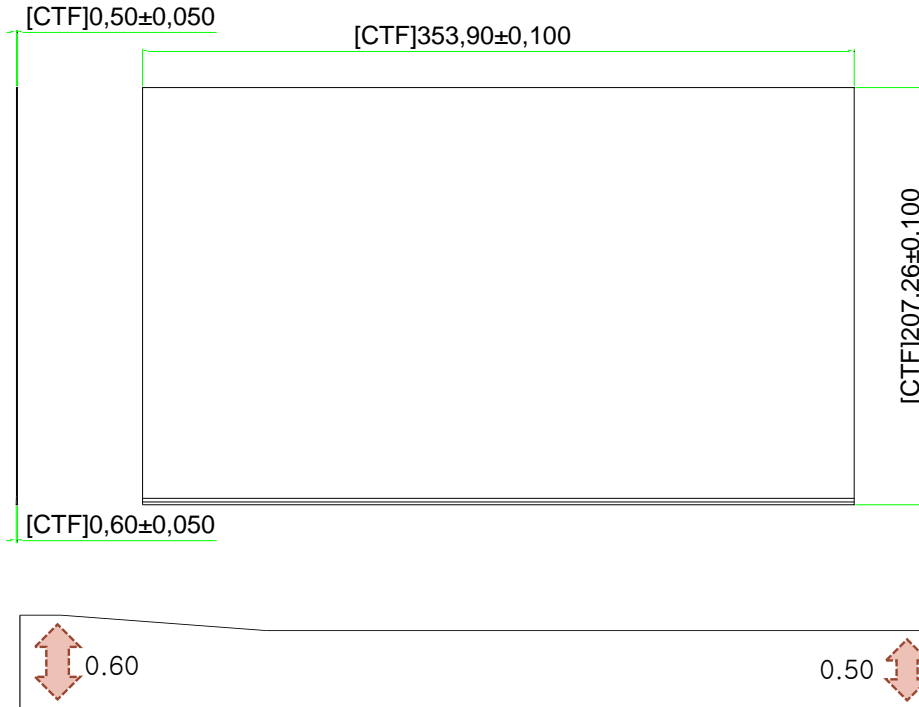

<Side View>

◆ Features

Parameter	Specification	Unit
Out Size	15.6"	Inch
	353.90(H) * 207.26(V) * 0.50(T)	mm
Structure	Top Face : UV varnish (clear) Bottom Face : Polycarbonate	-
Type	0.50T~0.60T (Wedge Type)	mm
	Flat Face : 0.50T Wedge : 0.60T	mm
Mirror Finishing		Four Faces
Remark	RoHS ,HF	-

◆ INV15H-14-01D

■ Light Guide Film

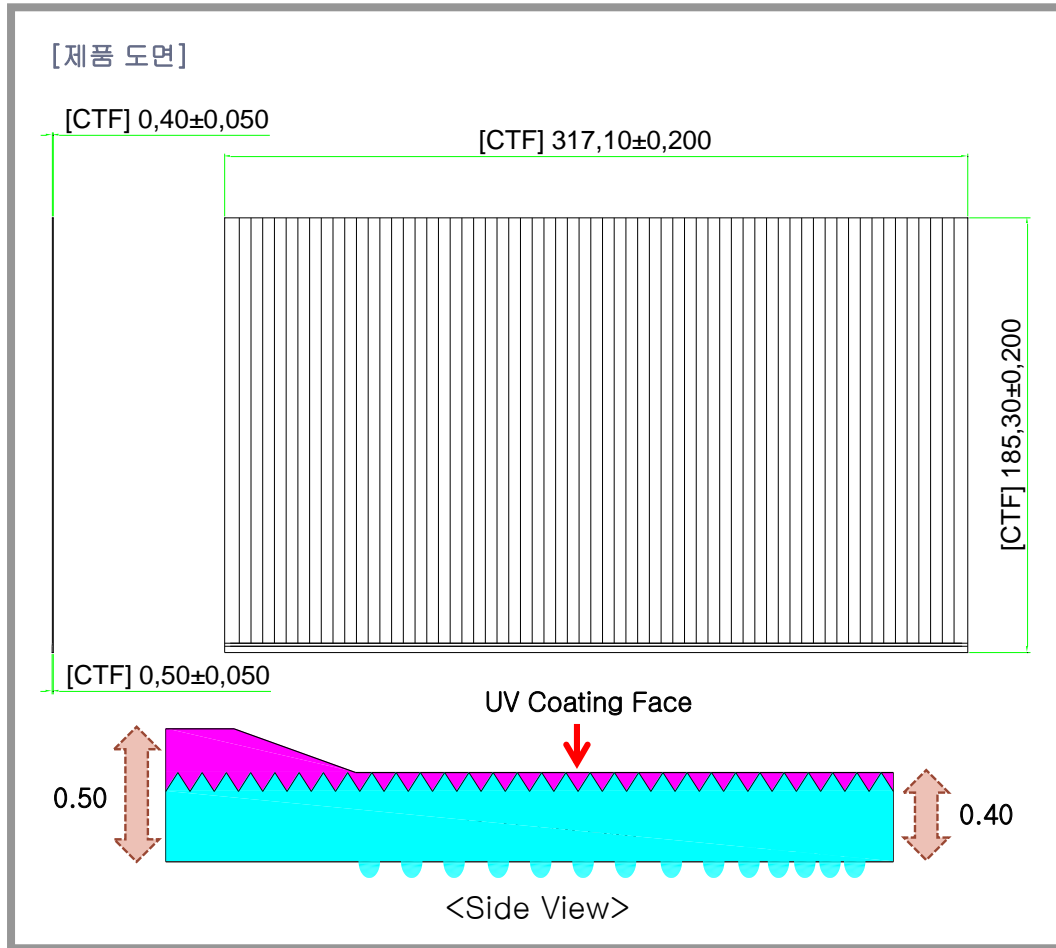

◆ Features

Parameter	Specification	Unit
Out Size	14"	Inch
	317.10(H) * 185.30(V) * 0.40(T)	mm
Structure	Top Face : UV varnish (clear) Bottom Face : Methylstyrene (Roll Stamping)	-
Type	0.40T~0.50T (Wedge Type)	mm
	Flat Face : 0.40T Wedge : 0.50T	mm
Mirror Finishing		Four Faces
Remark	RoHS ,HF	-

◆ INV15H-13.3-02D

■ Light Guide Film

[제품 도면]

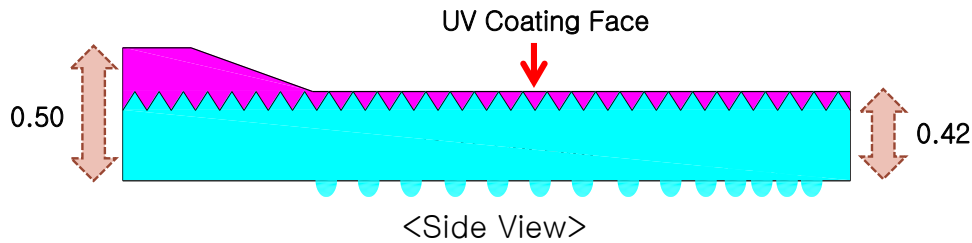
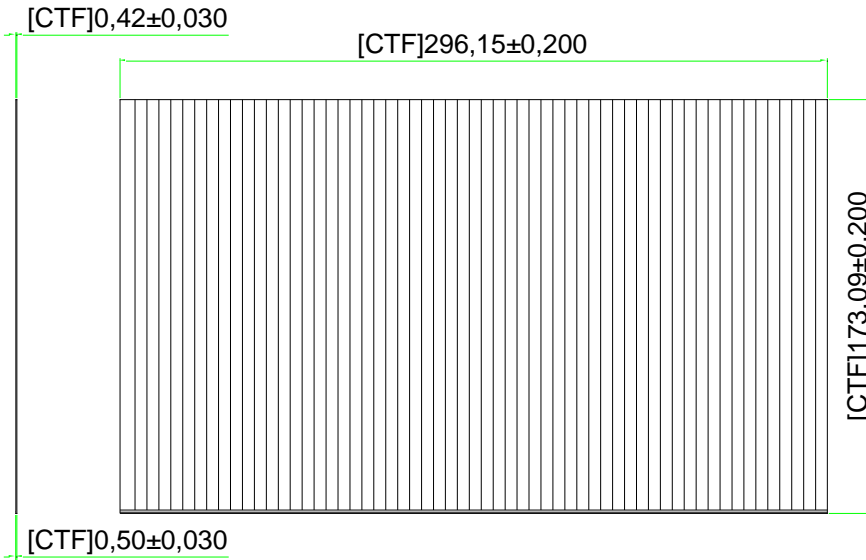

◆ Features

Parameter	Specification	Unit
Out Size	13.3"	Inch
	296.15(H) * 173.09(V) * 0.42(T)	mm
Structure	Top Face : UV varnish (clear) Bottom Face : Methylstyrene (Roll Stamping)	-
Type	0.42T~0.50T (Wedge Type)	mm
	Flat Face : 0.42 Wedge : 0.50T	mm
Mirror Finishing		Four Faces
Remark	RoHS ,HF	-

◆ INV16H-6.0-01D

■ Light Guide Film

[제품 도면]

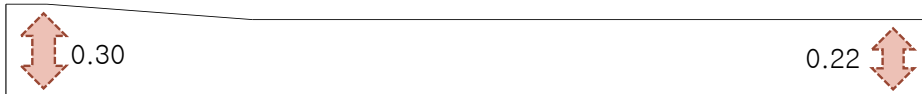
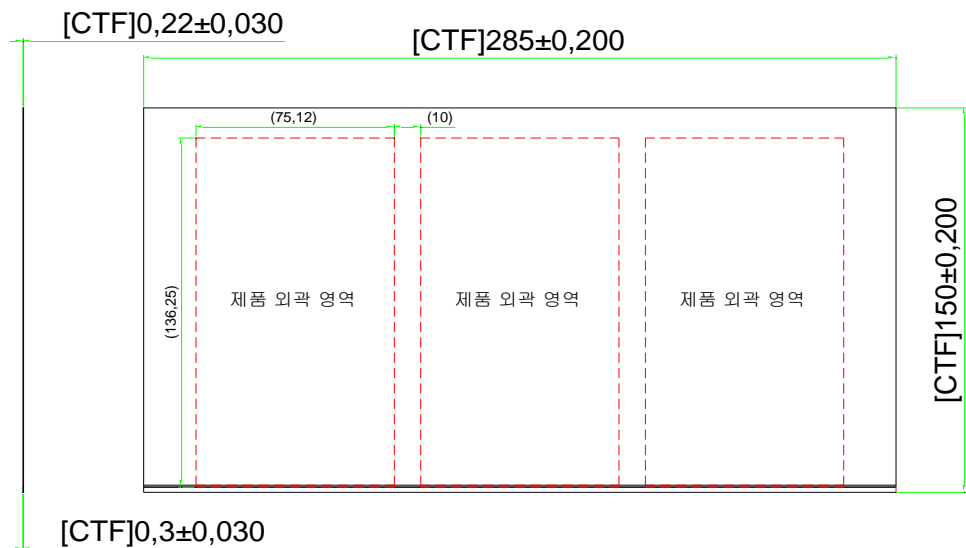

<Side View>

◆ Features

Parameter	Specification	Unit
Out Size	6.0" (3 배열)	Inch
	285.00(H) * 150.00(V) * 0.22(T)	mm
Structure	Top Face : UV varnish (clear) Bottom Face : Polycarbonate	-
Type	0.22T~0.30T (Wedge Type)	mm
	Flat Face : 0.22T Wedge : 0.30T	mm
Mirror Finishing	-	-
Remark	RoHS ,HF	-

◆ INV17A-5.5-01D

■ Light Guide Film

[제품 도면]

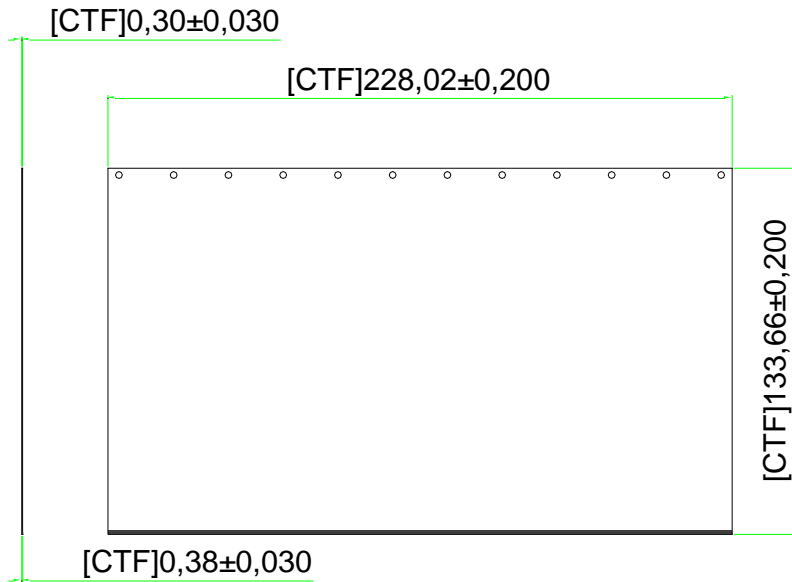

<Side View>

◆ Features

Parameter	Specification	Unit
Out Size	5.5" (3 배열)	Inch
	228.02(H) * 133.66(V) * 0.30(T)	mm
Structure	Top Face : UV varnish (clear) Bottom Face : Polycarbonate	-
Type	0.30T~0.38T (Wedge Type)	mm
	Flat Face : 0.30T Wedge : 0.38T	mm
Mirror Finishing		Four Faces
Remark	RoHS ,HF	-

◆ INV16J-6.0-LENTI

■ Light Guide Film

[제품 도면]

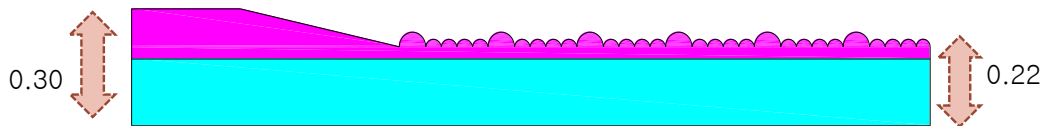
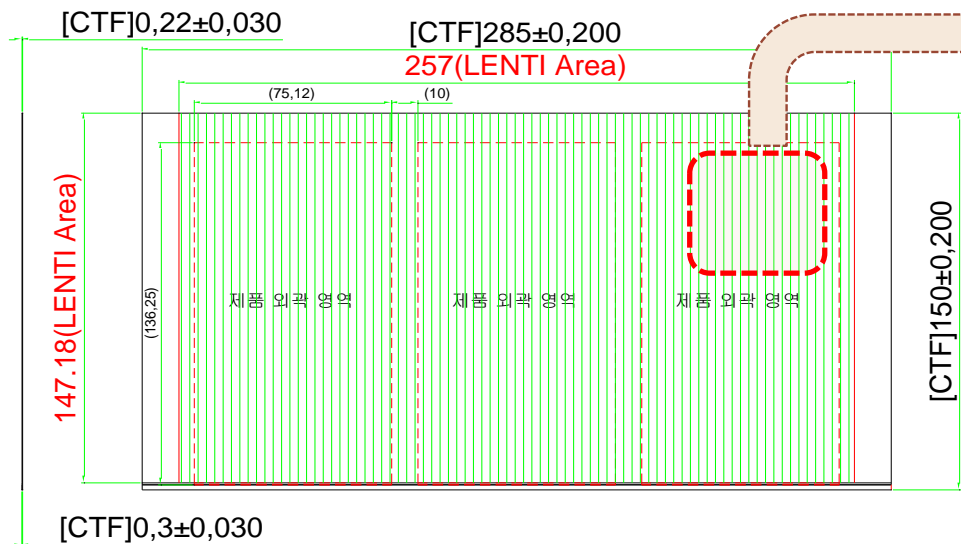

<Side View>

◆ Dual Lenticular Pattern (Top Face)

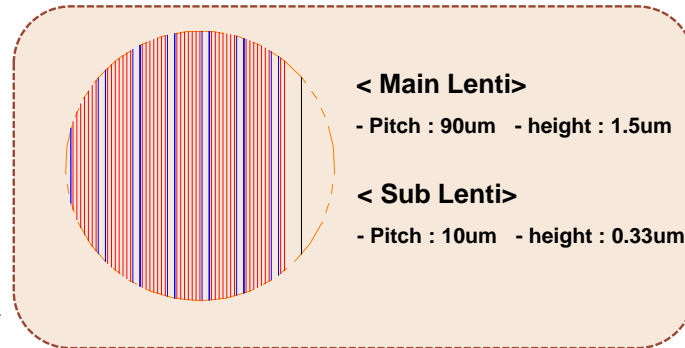

◆ Features

Parameter	Specification	Unit
Out Size	6.0" (3 배열)	Inch
	285.00(H) * 150.00(V) * 0.22(T)	mm
Structure	Top Face : UV varnish (clear) Bottom Face : Polycarbonate	-
Type	0.22T~0.30T (Wedge Type)	mm
	Flat Face : 0.22T Wedge : 0.30T	mm
Mirror Finishing	-	-
Remark	RoHS ,HF	-

◆ INV16i-6.0-LENTI

■ Light Guide Film

[제품 도면]

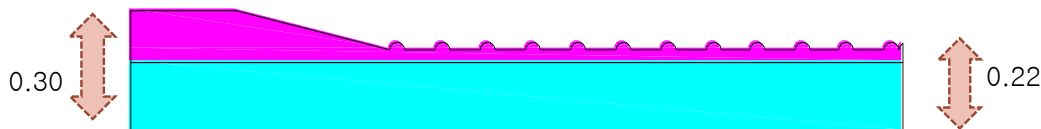
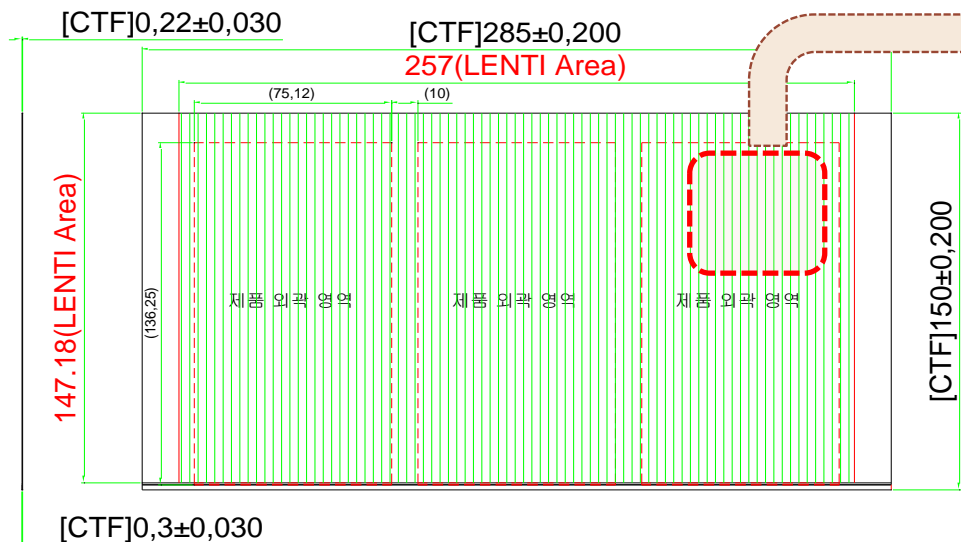

<Side View>

◆ Lenticular Pattern (Top Face)

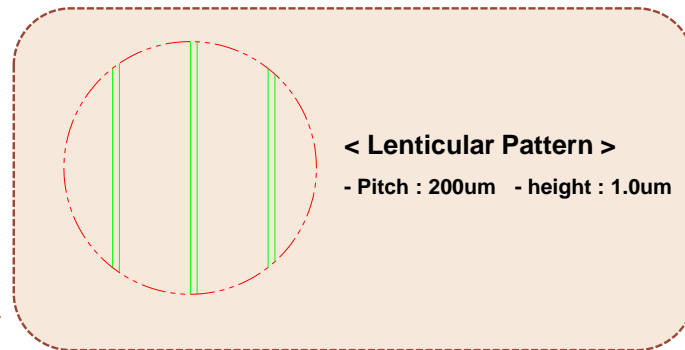

◆ Features

Parameter	Specification	Unit
Out Size	6.0" (3 배열)	Inch
	285.00(H) * 150.00(V) * 0.22(T)	mm
Structure	Top Face : UV varnish (clear) Bottom Face : Polycarbonate	-
Type	0.22T~0.30T (Wedge Type)	mm
	Flat Face : 0.22T Wedge : 0.30T	mm
Mirror Finishing	-	-
Remark	RoHS ,HF	-

◆ INV17A-5.5-02D-LENTI

■ Light Guide Film

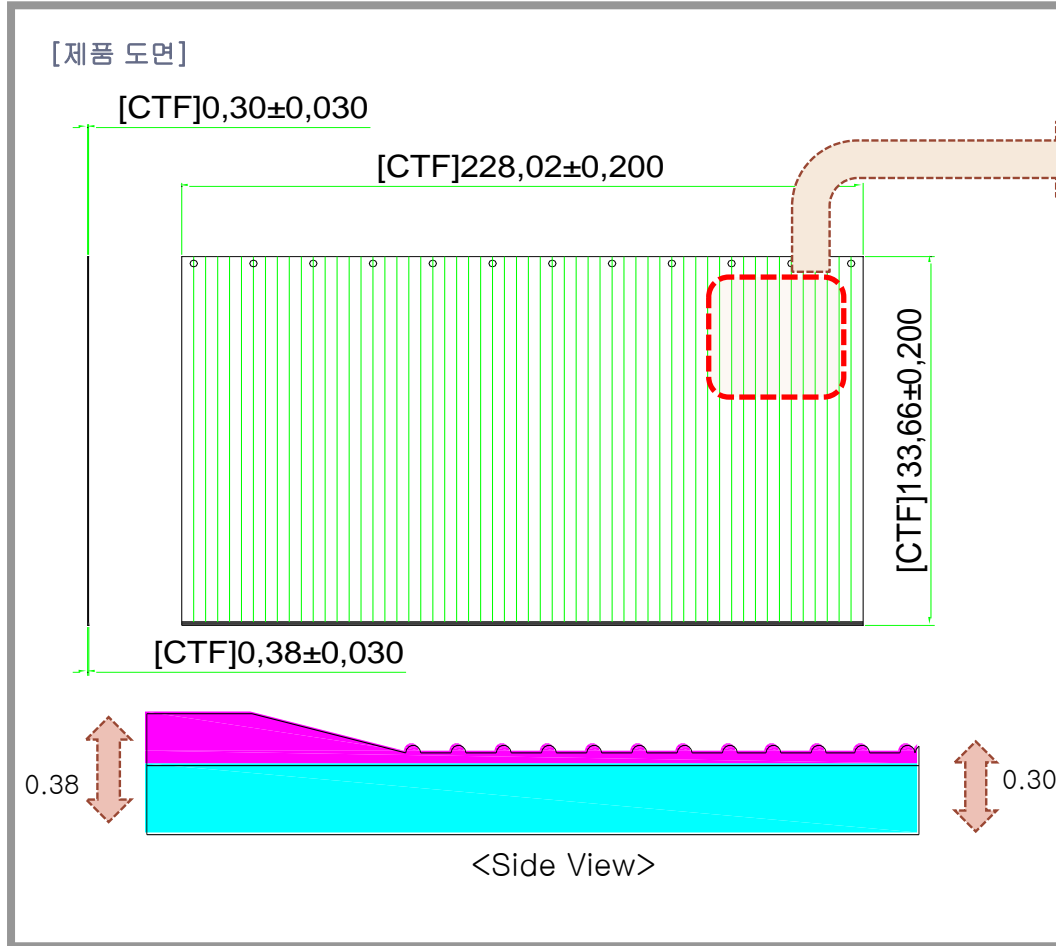

◆ Lenticular Pattern (Top Face)

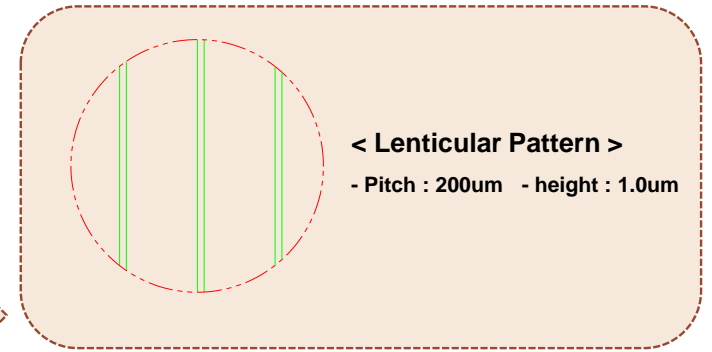

◆ Features

Parameter	Specification	Unit
Out Size	5.5" (3 배열)	Inch
	228.02(H) * 133.66(V) * 0.30(T)	mm
Structure	Top Face : UV varnish (clear) Bottom Face : Polycarbonate	-
Type	0.30T~0.38T (Wedge Type)	mm
	Flat Face : 0.30T Wedge : 0.38T	mm
Mirror Finishing		Four Faces
Remark	RoHS ,HF	-